



Tenditeloni e modanature

Per sponde da 25 mm

Lega 6060 T5

Anodizzati ARS1 10 micron e Grezzi

PROFILI IN ALLUMINIO

CODICE	DISEGNO	PESO Kg/ml	DESCRIZIONE	LUNGHEZZA (ml)			
				6	6,6	7	7,5
1257		0,962	PROFILO TENDITELO	X	X		
21170		2,746	MANIGLIA TENDITELO				X
13870		0,873	PROFILO TENDITELO	X	X		
21093		1,647	MANIGLIA TENDITELO		X		
21092		2,120	OMEGA PER SIST. FRANCESE		X		
22012		1,141	TENSIONATORE TELO DA 34 MM				X
			GREZZO	X			
MT 25x5		0,232	MEZZA MANDORLA DA 25	X			
51625		1,075	PROFILO PER CERNIERE	X			
51899		0,717	TENSIONATORE TELO DA 22 mm GREZZO	X			
2821		0,135	UNGHIETTA GREZZA	X			
2186		0,265	GOCCIOLATOIO GREZZO	X			

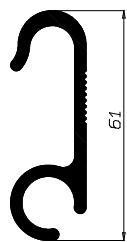

Art. 1257

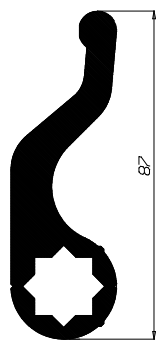

Art. 21170

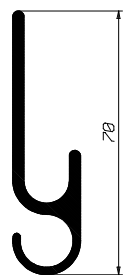

Art. 13870

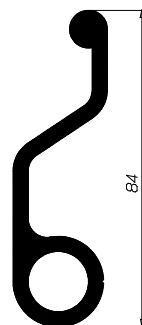

Art. 21093

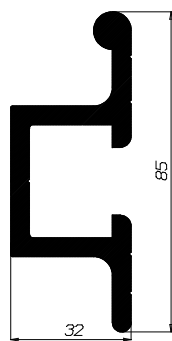

Art. 21092

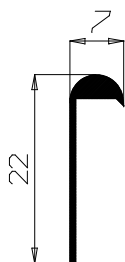

Art. 2821



Art. MT 25x5

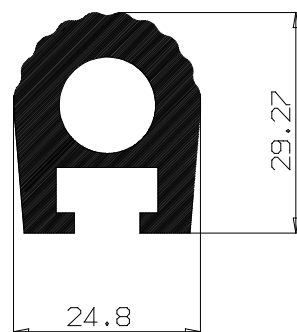

Art. 51625

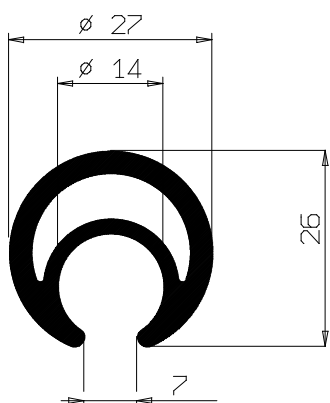

Art. 51899

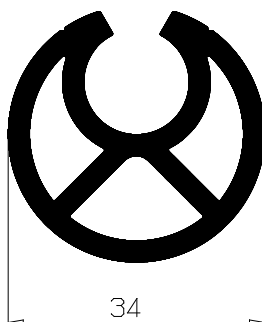

Art. 22012

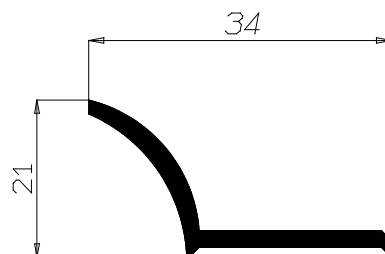

Art. 2186